

Installation and User Guide

MULTICAL® 6M2



Designations

Permissible operating conditions / measuring ranges

Calculator	θ : -40 °C.....140 °C	$\Delta\theta$: 3K...170K
Temperature sensor pair	θ : -40 °C.....140 °C	$\Delta\theta$: 3K...140K

Mechanical environment

M1 (fixed installation with minimum vibration).

M2 (significant or high level of vibration and shock).

Electromagnetic environment

E1 and E2 (domestic/light industry and industry). The meter's signal cables must be drawn at min. 25 cm distance to other installations.

Climatic environment

Must be installed in environments with non-condensing humidity as well as in closed locations (indoors). The ambient temperature must be within 5...55 °C.

Maintenance and repair

The district heating supplier can replace communication module, battery and temperature sensor pair. The flow sensor may also be replaced, but must be suitable for mixed fluid applications and possible sub-zero temperatures.

MULTICAL® 6M2, type 6M2-G/H must be connected to a temperature sensor pair type Pt500.

MULTICAL® 6M2, type 6M2-G can be connected to flow sensor type electronic pick-up or flow sensors with reed switch output.

MULTICAL® 6M2, type 6M2-H must be connected to a flow sensor with 24 V active pulse output.

Irrespective of flow sensor type, "pulses/litre" must be identical in flow sensor and calculator.

Battery for replacement

Kamstrup type 1606064.

Installation Guide

MULTICAL® 6M2

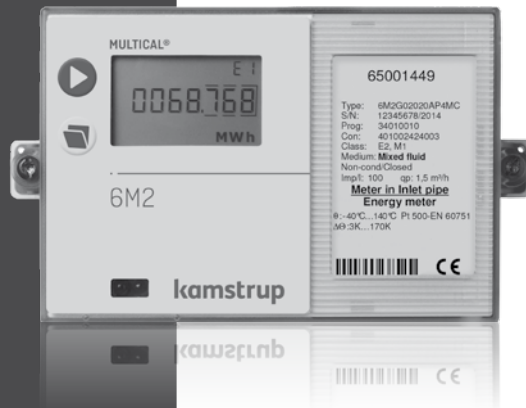

Contents

1	General information	4	6	Electrical connection, MULTICAL® 6M2	11
2	Mounting of temperature sensors	5	6.1	Connection of electronic pick up or reed switch units	11
	2.1 Pocket temperature sensor pair	5	6.2	Connection of units with active pulses	11
	2.2 Short direct temperature sensor pair	6	6.3	Connection example	12
	2.3 Temperature sensor pair in cooling applications	6	7	Voltage supply of calculator	13
3	Flow sensor	7	7.1	Battery supply	13
	3.1 Mounting of flow sensor	7	7.2	Mains modules	13
	3.2 GWF flow sensor	7	8	Testing of function	14
4	Mounting of calculator	9	9	Information codes "INFO"	14
	4.1 Separate/wall mounting	9	10	Plug-in modules	15
	4.2 Panel mounting	9	10.1	Module overview	15
5	Fluid type	10	10.2	Module description	15
	5.1 Fluid type code	10	11	Setup via front keys	17

1 General information

 **Read this guide before installing the meter.**

Kamstrup's warranty obligations do not apply in case of incorrect mounting.

Please note that the following installation conditions must be obeyed:

- Pressure stage Kamstrup sensor pair type DS: PN16
- Pressure stage Kamstrup stainless steel pockets: PN25/PN40 - depending on type

Note: Please be aware that depending on the flow part it may be recommended to use a flange meter at high medium temperatures.

2 Mounting of temperature sensors

The temperature sensors used to measure inlet and outlet temperatures respectively are a matched sensor pair that must never be separated.

Temperature sensors are usually mounted in MULTICAL® 6M2 from the factory. According to EN 1434 or OIML R75 the cable lengths must not be changed. If the cable lengths are changed it might result in a measurement error. If necessary, sensors must always be replaced in pairs.

The sensor marked with a red sign is to be installed in the inlet pipe. The other sensor marked with a blue sign is to be installed in the outlet pipe (see paragraph 6 for further information).

Note: The sensor cables must not be pulled. Be aware of this in case of binding the cables.

2.1 Pocket temperature sensor pair

Preferably, sensor pockets must be mounted in tee-pieces or in 45° lateral Y-pieces. The tip of the sensor pocket must be placed in the middle of the flow.

The temperature sensors should reach the bottom of the pockets. If a short response time is required, "non-hardening" heat conducting paste can be used.

Push the plastic sleeve on the sensor cable into the sensor pocket and secure the cable by means of the enclosed M4 sealing screw. Fasten the screw with your fingers only. Seal the pockets using seal and locking wire.

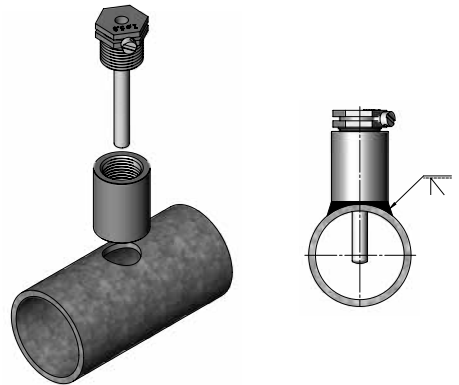

2.2 Short direct temperature sensor pair

The short direct sensors can be mounted in special ball valves or in special tee-pipes, both with threads up to R1 and built-in M10 union for the short direct sensor.

For mounting in existing installations with standard angle tees Kamstrup A/S can, furthermore, supply R $\frac{1}{2}$ and R $\frac{3}{4}$ brass nipple fittings for the short direct sensors.

Fasten the sensor's brass unions lightly (approx. 4 Nm) using a 12 mm face wrench and seal the sensors with seal and locking wire.

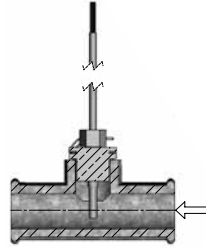

2.3 Temperature sensor pair in cooling applications

Temperature sensors in cooling applications must be mounted from below as shown in the figure.

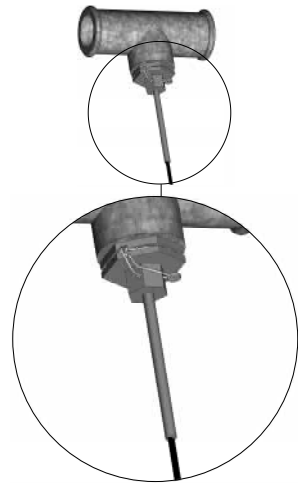

3 Flow sensor

The MULTICAL 6M2 must be used in connection with flow parts compatible with mixed fluids. Flow parts suitable for mixed fluids are e.g. mechanical and magnetic inductive.

3.1 Mounting of flow sensor

- A** Recommended flow sensor position.
- B** Recommended flow sensor position.
- C** Unacceptable position due to risk of air build-up.
- D** Acceptable in closed systems. Unacceptable position in open systems due to risk of air build-up in the system.
- E** A flow sensor ought not to be placed immediately after a valve, with the exception of block valves (ball valve type) which must be fully open when not used for blocking.
- F** A flow sensor should not be placed at the suction side of a pump.
- G** A flow sensor ought not to be placed after a double bend in two levels.

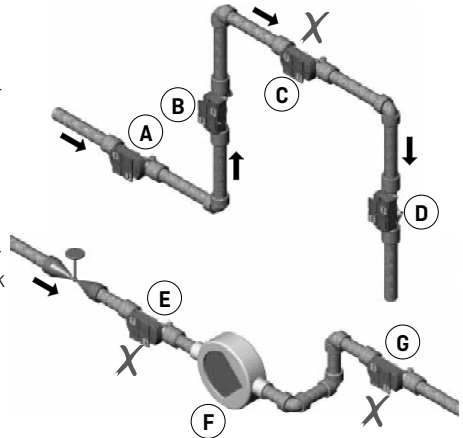

3.2 GWF flow sensor

GWF volume measuring meters can withstand installations where antifreeze agents are present. The measuring dynamics are, however, influenced depending on the concentration. With an anti-freeze concentration:

- 1 Below 5 % there is no influence on the measuring dynamics
- 2 At 30 % the q_i value is doubled.

Note: The q_i increases between 5-30 %. This degradation takes place proportionally.

- 3 Above 30 % we do not recommend these meters.

3.2.1 Mounting of GWF flow sensor

Single jet meters (Unico®) can be installed in horizontal or vertical pipelines. Horizontal installation is preferred since it offers superior measuring dynamics.

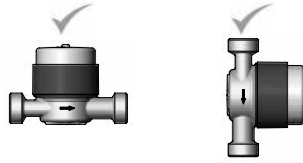

Multi jet meters (MTH) can only be installed in horizontal pipelines. The meter type plate must always face upwards.

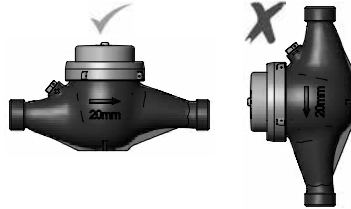

It is recommended to install shut-off valves before and after the meter, to facilitate the installation and removal of the meter for periodic inspection and maintenance work.

Pay attention to the direction of flow when installing the meter. An arrow on the meter body indicates the direction of flow.



Note: The meter should be protected against mechanical jolts or vibration, which could be present in the installation.

4 Mounting of calculator

The MULTICAL® 6M2 calculator can be mounted in two different ways:

4.1 Separate/wall mounting

The wall fitting makes it possible to mount MULTICAL® 6M2 direct on an even wall. Use the fitting as a template to mark and drill two 6 mm holes in the wall.

Naturally, wall mounting is ideal when mounting in condensing environments.

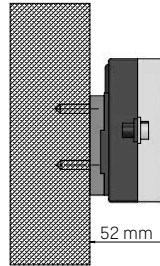

4.2 Panel mounting

MULTICAL® 6M2 can be mounted direct in panels and control panels, via Kamstrup's panel mounting kit, No. 66-99-104 (192 x 144 mm).

5 Fluid type

MULTICAL® 6M2 is compatible with the most commonly used antifreeze liquids, e.g. ethylene glycol, propylene glycol, Tyfocor and Antifrogen.

5.1 Fluid type code

The type of antifreeze liquid and the concentration are freely programmable and thus MULTICAL® 6M2 can compensate for the unique specific heat capacity in each application, ensuring a high accuracy regardless of the chemical composition or the application.

The fluid type code is a 4 digit code, which states the fluid type and concentration, for which the calculator is programmed. The fluid type code can be viewed in the calculator's display [reference number 71].



6 Electrical connection, MULTICAL® 6M2

MULTICAL® 6M2 can be connected to electronic pick up or reed switch units as well as units with active pulses. How to connect these flow sensors and the temperature sensors is described below.

6.1 Connection of electronic pick up or reed switch units

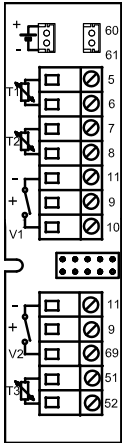

Flow sensors with reed switch output and electronic pick up units are connected to terminals 11-10 and 11-69 respectively.

The polarity of temperature sensors T1, T2 and T3 is unimportant.

	V1	V2
-	11	11
SIG	10	69

	Terminal no.	Standard heat and cooling measurement
T1	5-6	Sensor in inlet (red)
T2	7-8	Sensor in outlet (blue)
V1	11-10	Flow sensor in inlet or outlet
V2	11-69	-
T3	51-52	-

6.2 Connection of units with active pulses

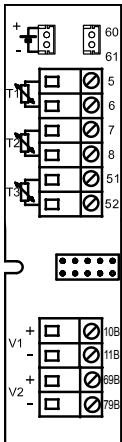

Flow sensors with active pulses are connected to terminals 11B-10B and 79B-69B respectively.

The polarity of temperature sensors T1, T2 and T3 is unimportant.

	V1	V2
-	11B	79B
SIG	10B	69B

	Terminal no.	Standard heat and cooling measurement
T1	5-6	Sensor in inlet (red)
T2	7-8	Sensor in outlet (blue)
V1	11B-10B	Flow sensor in inlet or outlet
V2	79B-69B	-
T3	51-52	-

6.3 Connection example

Example of connection of MULTICAL® 6M2 (type no. 6M2-G) and a flow sensor with a reed switch.

The passive contact output of the flow sensor is connected directly to the flow sensor input which is not galvanically separated. This permits a cable length of max. 10-20 m between flow meter and calculator.

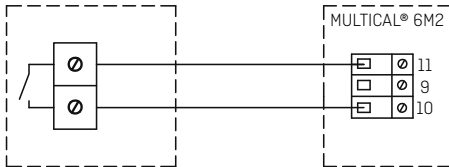

Example of connection of MULTICAL® 6M2 (type no. 6M2-H) and a flow sensor with active pulses.

The active pulse output of the flow sensor is connected to the galvanically separated flow sensor input directly. This permits a cable length of up to 100 m between flow sensor and calculator.

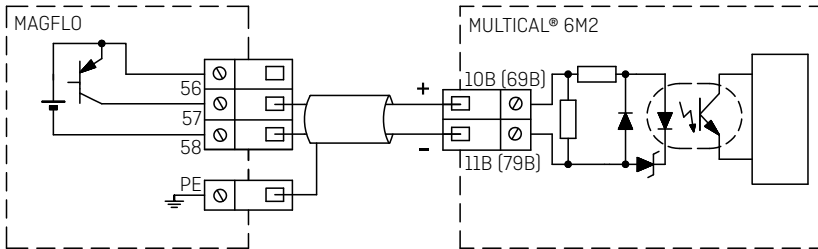

7 Voltage supply of calculator

MULTICAL® 6M2 can be powered by a built-in lithium battery or an integral 24 VAC or 230 VAC mains module.

The cable from battery or mains module is mounted in the calculator's connector by a two-pole plug.

7.1 Battery supply

MULTICAL® 6M2 is connected to a lithium battery, D-cell. The battery is marked with installation year, e.g. 2015, as well as production date.

Optimal battery lifetime is obtained by keeping the battery temperature below 30 °C.

The voltage of a lithium battery is almost constant throughout the lifetime of the battery (approx. 3.65 V). Therefore, it is not possible to determine the remaining capacity of the battery by measuring the voltage.

The battery cannot and must not be charged and must not be short-circuited for more than 2 sec. Used batteries must be handed in for approved destruction, e.g. at Kamstrup A/S.

7.2 Mains modules

The modules are protection class II. They are connected by means of a two-wire cable (without ground) through the cable entry of the calculator placed in the right side of the connecting base. Use connecting cable with 5-10 mm outer diameter and ensure correct stripping as well as correct mounting of cable relief.

Max. permitted fuse: 6 A.

National regulations for electric installations must be observed.

7.2.1 Isolated linear supply modules

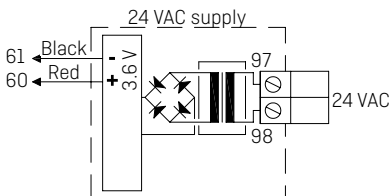

24 VAC

For instance 230/24 V transformer, type 66-99-403, can be used.

Note: MULTICAL® 6M2 cannot be powered by 24 VDC.

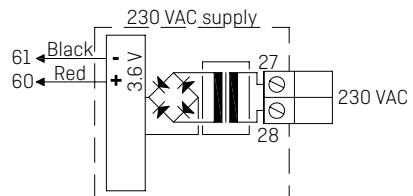

230 VAC

This module is used in connection with direct mains connection.

Note: External supply must be connected to the supply module.

8 Testing of function

Carry out an operational check when the energy meter has been fully mounted. Open thermo regulators and valves to establish flow through the system. Activate the main key of MULTICAL® 6M2 and check that the displayed values for temperatures and flow are relevant values.

9 Information codes "INFO"

MULTICAL® 6M2 constantly monitors a number of important functions. In case of a serious error in measuring system or installation, "INFO" is displayed and an info-code can be read by activating the main key until the measuring unit says "INFO". The info code is only displayed when the error is present.

Info code	Description	Response time
0	No irregularities	-
1	Supply voltage has been interrupted	-
8	Temperature sensor T1 outside measuring range	1...10 min.
4	Temperature sensor T2 outside measuring range	1...10 min.
32	Temperature sensor T3 outside measuring range	1...10 min.

If a number of info codes appear at a time, the sum of info codes is displayed. If e.g. both temperature sensors are outside measuring range, info code 12 is displayed.

10 Plug-in modules

MULTICAL® 6M2 can be extended by a range of extra functions by means of plug-in modules. The individual modules are briefly described below.

10.1 Module overview

MULTICAL® 6M2 Communication top module

Type No.	Description	Module No.
602-0C	2 pulse outputs for CE and CV	5550-1163

MULTICAL® 6M2 Communication base modules

Type No.	Description	Module No.
67-00-20	M-Bus + pulse inputs (VA, VB)	5550-831
67-00-24	LonWorks, FTT-10A + pulse inputs (VA, VB)	5550-1128
67-00-66	BACnet MS/TP (B-ASC) RS-485 + 2 pulse inputs	5550-1240
67-00-67	Modbus RTU + 2 pulse inputs	5550-1277

10.2 Module description

10.2.1 2 pulse outputs for CE and CV, type 602-0C

This top module has two configurable pulse outputs, which are suitable for volume and energy pulses for heat meters, cooling meters and combined heat/cooling meters.

The pulse resolution follows the display (determined by the CCC-code). E.g. CCC=010 (q_p 0,6...1,5): 1 pulse/0.1 kWh and 1 pulse/0.001 m³.

The pulse outputs are optoisolated and withstand 30 VDC and 10 mA. Normally energy (CE) is connected to 16-17 and volume (CV) to 18-19, but other combinations can be selected by means of the PC program METERTOOL, which is also used for selecting the pulse at either 32 or 100 ms.

10.2.2 M-Bus, type 67-00-20 (rev. B1 or higher)

M-Bus can be mounted in star, ring or bus topology. Up to 250 meter points can be connected depending on the M-Bus Master's power supply and the total cable resistance.

Cable resistance < 29 Ohm

Cable capacity < 180 nF

The M-Bus network is connected to terminals 24 and 25. The polarity is unimportant.

M-Bus comes with pulse inputs.

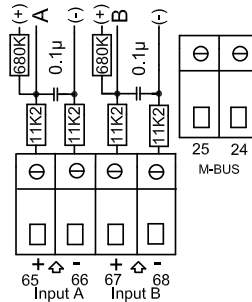

10.2.3 Lon Works, type 67-00-24 (rev. A1 or higher)

The LON module is used for transfer of data from MULTICAL® 6M2 either for data reading or for adjustment purposes via the LON bus, which is ideal for i.e. climate control and building automation. Data is communicated at a high speed which makes it possible to connect many applications to the same LON network.

Cabling between the LON module and the other LON-nodes is made with a standard twisted pair cable. The length can be up to 2700 m using bus topology or 500 m using free topology. The LON module is built up as a separate network node with neuron chip, memory, transceiver and input/output circuit. The module requires external supply [24 VAC /230 VAC] of MULTICAL® 6M2, battery supply is not possible.

The LON module collects new data from MULTICAL® 6M2 in a cycle which secures that all data are updated every 30 seconds.

10.2.4 BACnet®, type 67-00-66 (rev. J1 or higher)

The BACnet® module communicates with BACnet® on MS/TP via RS-485 as a master/slave or slave device.

The BACnet® module transfers a number of both actual data and accumulated data. Furthermore, info codes can be transmitted to the BACnet® Controller. The two pulse inputs allow connection and reading of two additional meters for e.g. water and electricity with pulse output.

10.2.5 Modbus, type 67-00-67 (rev. B1 or higher)

The Modbus base module for MULTICAL® 6M2 ensures simple integration from Kamstrup's heat, cooling and water meters into a Modbus based system. The Modbus module communicates as an RTU (Remote Terminal Unit) slave device on RS-485. The Modbus module transfers a number of both actual data and accumulated data. The RS-485 port of the Modbus module is galvanically separated from the meter's voltage potential, thereby improving the security for smooth operations. At the same time, the risk of influencing the meter due to influences of the RS-485 port is reduced to a minimum.

11 Setup via front keys

Date, time and primary M-Bus address can be adjusted by means of the front keys on the calculator's front.

- 1 In the display you select the reading you want to change
- 2 Lift off the calculator top
- 3 Wait until the meter has shut down (up to 2.5 minutes). Do not press any keys
- 4 While remounting the calculator top, keep the main key activated  for approx. 8 seconds.
- 5 The setup menu is now active.

Having activated the setup menu the reading you want to change is displayed with the rightmost digit flashing:



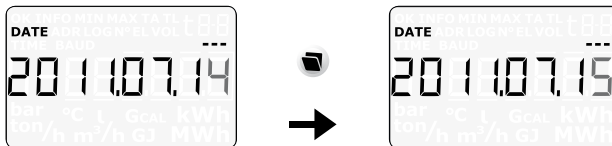

(in the below example, the "Date" has been selected):

The value of the flashing digit can be changed by pressing the sub-key . The digit is increased by one each time the key is pressed, and passing 9 you start from 0:

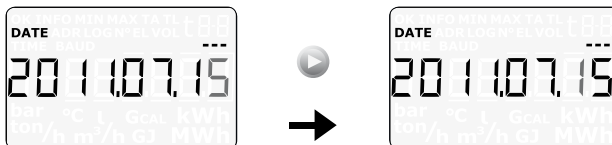

When pressing the main-key  the next digit to the right will be flashing:



The active digit flashes and this digit can now be changed by pressing the sub-key . It is possible to return to the first digit on the right by means of the main key .

When the value of the reading has been changed you quit by pressing the main key  continuously for approx. 10 seconds.

It should be checked whether the value is valid for the reading in question. If so, the value is saved and an "OK" symbol is displayed. If not, the old value is maintained, no "OK" symbol appears, and the display reverts to legal reading.

User guide

Energy Measurement

MULTICAL® 6M2 functions in the following way:

The **flow sensor** registers the amount of flow circulating through the system in m³ (cubic metres).

The **temperature sensors** placed in inlet and outlet pipes, register the cooling or heating, i.e. the difference between input and output temperatures.

MULTICAL® 6M2 calculates consumed energy based on volume of the antifreeze liquid and temperature difference.

Readings

When the main key  is activated, a new reading appears.

The sub-key  displays historical readings and average values.

Four minutes after the latest activation of the main key the meter automatically switches to consumed energy.

Displays

Consumed energy in kWh,
MWh or GJ.

 E 1
0045321
MWh

 Latest target date.

DATE LOG 0 1
20110601

LOG 0 1
0031107
MWh
Energy count on latest target date followed by energy count on last year's target date.
Followed by monthly counts.

Fluid type code.

N° 1
1130

Consumed water.

VOL. 1
0032456
m³

DATE LOG 0 1
20111101

LOG 0 1
0023195
m³
Volume count on latest target date followed by volume count on last year's target date.
Followed by monthly counts.

Number of operating hours.

 0008760
h

 50
14
Number of hours with errors.

Current inlet temperature.

t 1
7689
°C



Current outlet temperature.

t 2
3421
°C

Current T3 temperature.

t 3
500
°C

Current water flow.

 Activate  to see this year's max. value as well as yearly and monthly logging values.

VOL. 1
316
l/h



 20110317
Date of highest registered flow this year

Current water flow of flow meter connected to V2.

VOL. 2
1254
l/h

 1474
The highest registered flow followed by monthly max. and min. counts.

Current heat-flow rate.

 Activate  to see this year's max. value as well as yearly and monthly logging values.

VOL. R
146
kW

Followed by accumulated water consumption at inputs A and B and tariff registers TA2 and TA3.
Totalized water consumption on input A.

VOL. R
0015638
m³

 75420145
Serial number of equipment connected to input A.
Followed by yearly and monthly logging values.

Totalized water consumption on input B.



Current information code.

(Contact your district heating company if the value differs from "0").



The first max. 8 digits of the customer number.

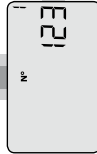

Serial number of equipment connected to input B. Followed by yearly and monthly logging values.

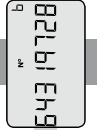

Reading of number of INFO code events.

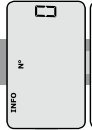

Data logger shows date ...



... and then the INFO codes of the latest 36 events.



The last 8 digits of the customer number. This example displays customer number 12345678912.

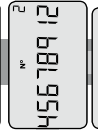

Current date. Followed by actual time.



Target date displayed as month and day. In this example June 1.



The calculator's serial number. Followed by program number, config 1 and 2, software edition and software checksum.



Display test. Followed by top and base module types.



Type of top module. Followed by Top module secondary address, base module type and primary and secondary addresses.



(*) DDD = 401

Also see interactive user's guides at www.kamstrup.com.

User Guide

MULTICAL® 6M2

